

COMMISSIONING

Wiring

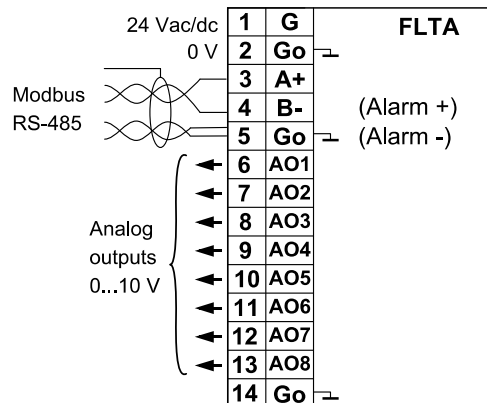

Device wiring and commissioning can only be carried out by qualified professionals. Always make the wirings while the power is switched off.



After switching power on for the first time, FLTA displays version number shortly and after that "SET" starts to flash.

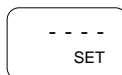

The base station settings can be configured through the menu. After configuring the settings, the transmitters and I/O modules can be connected to the base station by using the FLSER commissioning tool. See the commissioning instructions for transmitters and I/O modules from the documentation of the device in question.

Placing the FLAN antenna

The ideal FLTA antenna installation place is the central location in the network area. The antenna should be at least 10...15 cm away from the wall corner or concrete ceiling. The antenna should be installed on a large ferromagnetic metal board (e.g. air duct inside a false ceiling) to create adequate anti-pole.

The default FLAN antenna cable length is 4 meters. If needed, the cable can be extended with FLANJJ-4,5 (4,5 m) extension cable.

NOTE: Do not use more than one extension cable. All extra joints considerably dampen the radio signal.

Menu

The menu can be activated by pushing the M button for approximately 5 seconds. You can proceed in the menu by pushing the M button. The values can be changed with the "+" and "-" buttons.

The settings are saved when you leave the menu.

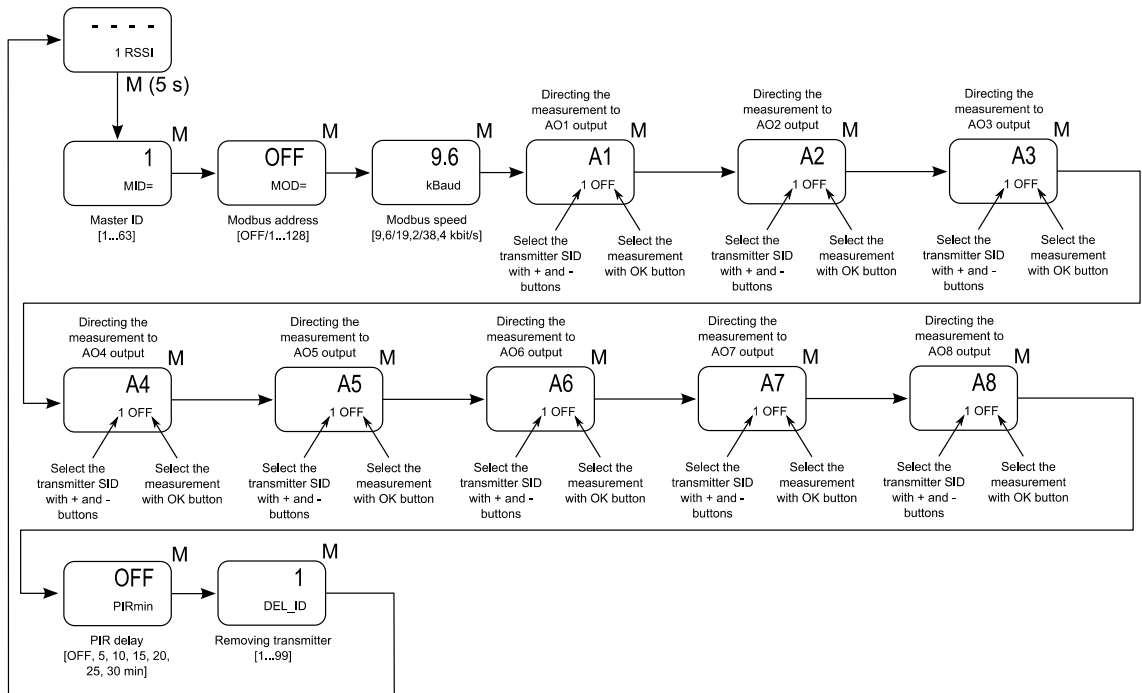

Testing the network coverage

1. Move the FLSER commissioning tool switch to the RSSI position.

"On CARE" text appears on FLTA display and RX indicator light flashes rapidly.

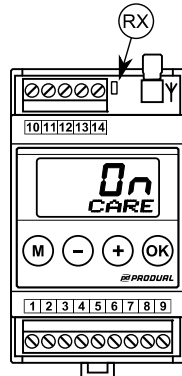

2. Take the FLSER commissioning tool to the planned installation places and check the signal strength from the commissioning tool display.

NOTE: Do not hold the FLSER tool in your hand when testing, because that disturbs the signal strength measurement.

FLTA displays base station (small number) and transmitter (big number) signal strengths (1...2 = poor, 3...5 = acceptable and 6...9 = good).



3. After testing, move the FLSER switch to OFF position.

The base station is now ready for use. "On CARE" text disappears from the FLTA display.

NOTE: If the network range is not adequate, a repeater is needed.

OPERATING AFTER A POWER FAILURE

The base station outputs return to the state before the power failure.

ANALOGUE OUTPUTS

The transmitter signals can be directed to one or more base station analogue outputs. Analogue outputs can be set through the menu.

NOTE: The FLTA base station analogue outputs (AO1...AO8) cannot be controlled via Modbus.

You can select the wanted analogue output (AO1...AO8), transmitter number with the "+" and "-" buttons and measurement information with the OK button.

A3
3 TE

Device	Information	0...10 V signal range
TEFL(-RH-P-S5)	Temperature	0...50 °C
	Humidity	0...100 %rH
	Set point	18...24 °C
	5-position switch (A, 0, 1, 2, 3)	A = 1 V, 0 = 2 V, 1 = 3 V, 2 = 4 V, 3 = 5 V
	Digital input	0 = 0 V, 1 = 10 V
TEUFL	Temperature	-50...+150 °C
	Analogue input	0...10 V
TEUFL-DI	Temperature	0...50 °C
	Digital input	0 = 0 V, 1 = 10 V
KLUFL (+LUX 11)	Temperature	-50...+150 °C
	Humidity	0...100 %rH
	Luminosity	0...2000 lx
HDHFL(-RH)	Temperature	-50...+150 °C
	Carbon dioxide concentration	0...2000 ppm
	Humidity	0...100 %rH
LAFL(-LX)	Occupancy detection	no detection = 0 V detection = 10 V
	Luminosity	0...2000 lx
RYFL	Analogue input	0...10 V
	Digital input	0 = 0 V, 1 = 10 V

NOTE: The analogue output keeps its latest output value if FLTA loses contact to the transmitter.

MOVEMENT DETECTORS (PIR)

Wireless LAFL (PIR) movement detectors can be connected to the FLTA base station.

Detected movement on the LAFL detector controlling area causes immediate detection information on the base station. If movement is not detected during next 4 minutes, the no detection information is sent to the base station. "Detection" and "no detection" information are delivered to the base station without delay.

The FLTA analogue output delay (default = OFF (4 min) and selectable 5, 10, 15, 20, 25, 30 min) can be adjusted through the menu.

OFF
PIRmin

USER MODE

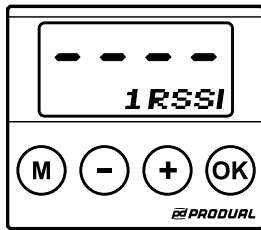

The transmitter information is displayed on the FLTA base station display.
The transmitter can be changed with "+" ja "-" buttons.
With OK button it is possible to change the transmitter measurement information to be displayed.

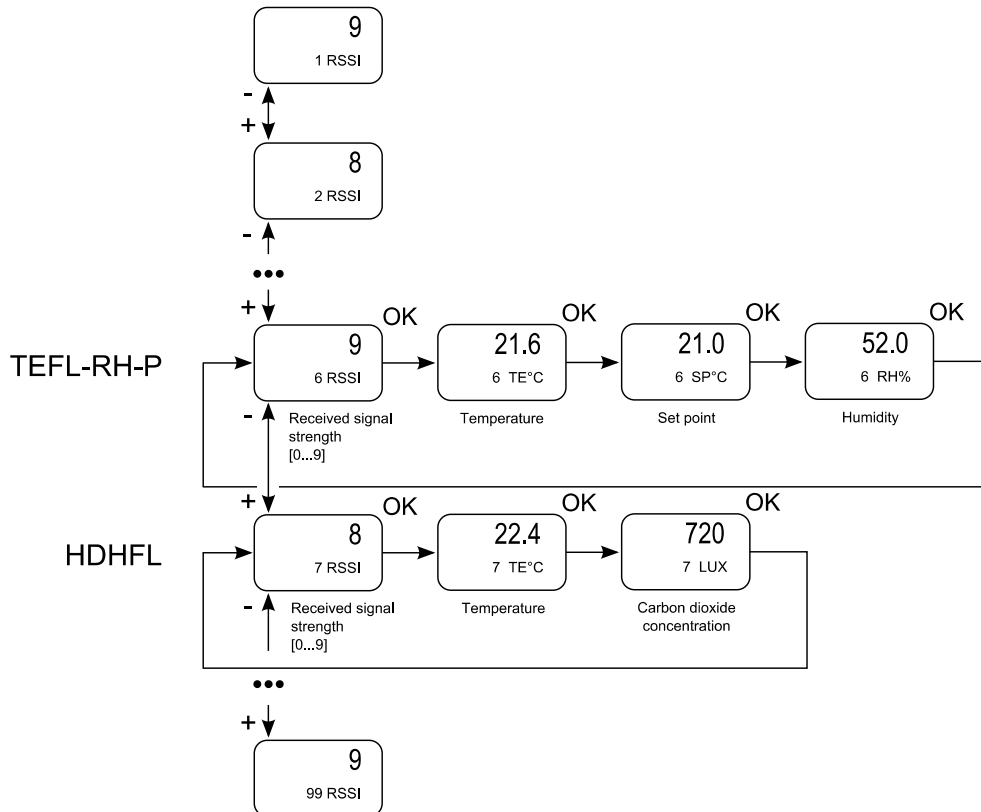

ALARMS

The alarm can be caused by transmission problem (the base station has lost the contact to the transmitter) or low battery (approx. 5 % of capacity remaining).

There are two types of alarms depending on the Modbus usage.

<p>If the Modbus is used, the alarms can only be read via Modbus. For example, a transmitter with SID 5, sends the following unique alarm:</p> <ul style="list-style-type: none"> - Alarm (register 201 = 1) - Low battery (register 10005 = 1) - Transmission problem (register 10105 = 1) <p>NOTE: The alarm does not appear on the display.</p> <p>The alarm can be reset via Modbus.</p>	<p>Modbus ID [1..128]</p>
<p>If the Modbus is not used, the alarm can be read from the display and via the terminal 4 (B-) (5 V = alarm). The alarm information can be forwarded to the building controller by using the voltage relay RY 1-U, for example.</p> <p>The alarm can be reset by pushing OK button for over 5 seconds.</p>	<p>Modbus ID [OFF]</p>

REMOVING AN UNNECESSARY TRANSMITTER FROM THE NETWORK

NOTE: Unnecessary transmitter should always be removed from the FLTA database to prevent alarms.

1. Disconnect the power supply from the unnecessary transmitter.
2. Set the FLSER tool switch to the MID position.
3. Push the + and - buttons to select the FLTA base station master ID (MID) from which you are removing the transmitter.

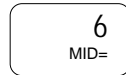

4. Push the OK button.
5. Set the FLSER tool switch to the S-RID position.
6. Push the + and - buttons to select OFF for the transmitter sensor ID (SID).



7. Push the OK button.
"Wait" message starts to flash on the FLSER tool display. You have now approximately 30 seconds to complete the next step.
8. Connect the power supply to the transmitter you are going to remove.
"OK" flashes on the FLSER display. Wait until the flashing stops.
9. Set the FLSER tool switch to the OFF position.
10. Navigate to the DEL_ID position in the FLTA menu.

NOTE: The menu can be activated by pushing the M button for approximately 5 seconds.

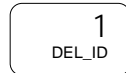

11. Press + and - buttons to select the SID of the transmitter to be removed.



12. Push the OK button.
The confirmation question appears on the display.



13. Push the OK button to confirm the removal.

NOTE: With the 'M' button you can proceed without accepting the selection.

MODBUS

Modbus is in OFF mode as default. Modbus can be activated through the menu.

NOTE: The Modbus mode affects to the alarm functions. See page 4, Alarms

Bus properties

Protocol	RS-485 Modbus RTU
Bus speed	9600/19200/38400 bit/s
Data bits	8
Parity	none
Stop bits	1
Network size	up to 128 devices per segment

Modbus function codes

The device supports the following Modbus function codes.

0x01	Read Coils
0x02	Read Discrete Inputs
0x03	Read Holding Registers
0x04	Read Input Registers
0x05	Write Single Coil
0x06	Write Single Register
0x0F	Write Multiple Coils
0x10	Write Multiple Registers
0x16	Mask write Register

NOTE: The Modbus commands must have at least 500 ms interval.

Modbus registers

NOTE: If you try to write a parameter value that is beyond the parameter value range, the value will be replaced by the nearest acceptable value.

Example:

1. The register value range is -500...500.
2. You try to write the value 600 to the register.
-> the value 500 is written to the register.

Coils

Register	Parameter description	Data type	Values	Range
				See note 1
1	SID 1, DO1	Bit	0 - 1	0: Off, 1: On
2	SID 2, DO1	Bit	0 - 1	0: Off, 1: On
...	...			
98	SID 98, DO1	Bit	0 - 1	0: Off, 1: On
99	SID 99, DO1	Bit	0 - 1	0: Off, 1: On
101	SID 1, DO2	Bit	0 - 1	0: Off, 1: On
102	SID 2, DO2	Bit	0 - 1	0: Off, 1: On
...	...			
198	SID 98, DO2	Bit	0 - 1	0: Off, 1: On
199	SID 99, DO2	Bit	0 - 1	0: Off, 1: On
201	Alarm	Bit	0 - 1	0: Off, 1: On

Discrete inputs

Register	Parameter description	Data type	Values	Range
10001	SID 1, low battery	Bit	0 - 1	0: Off, 1: On
10002	SID 2, low battery	Bit	0 - 1	0: Off, 1: On
...	...			
10098	SID 98, low battery	Bit	0 - 1	0: Off, 1: On
10099	SID 99, low battery	Bit	0 - 1	0: Off, 1: On
10101	SID 1, lost	Bit	0 - 1	0: Off, 1: On
10102	SID 2, lost	Bit	0 - 1	0: Off, 1: On
...	...			
10198	SID 98, lost	Bit	0 - 1	0: Off, 1: On
10199	SID 99, lost	Bit	0 - 1	0: Off, 1: On
10201	SID 1, PIR	Bit	0 - 1	0: Off, 1: On
10202	SID 2, PIR	Bit	0 - 1	0: Off, 1: On
...	...			
10298	SID 98, PIR	Bit	0 - 1	0: Off, 1: On
10299	SID 99, PIR	Bit	0 - 1	0: Off, 1: On
10301	SID 1, DI1	Bit	0 - 1	0: Off, 1: On
10302	SID 2, DI1	Bit	0 - 1	0: Off, 1: On
...	...			
10398	SID 98, DI1	Bit	0 - 1	0: Off, 1: On
10399	SID 99, DI1	Bit	0 - 1	0: Off, 1: On
10401	SID 1, DI2	Bit	0 - 1	0: Off, 1: On
10402	SID 2, DI2	Bit	0 - 1	0: Off, 1: On
...	...			
10498	SID 98, DI2	Bit	0 - 1	0: Off, 1: On
10499	SID 99, DI2	Bit	0 - 1	0: Off, 1: On

Input registers

Register	Parameter description	Data type	Values	Range
30002	Discrete inputs 16 - 01	16 bit		
30003	Discrete inputs 32 - 17	16 bit		
	...			
30032	Discrete inputs 496 - 481	16 bit		
30033	Discrete inputs 512 - 497	16 bit		
30034	Coils 16 - 01	16 bit		
30035	Coils 32 - 17	16 bit		
	...			
30045	Coils 192 - 177	16 bit		
30046	Coils 208 - 193	16 bit		
				See note 1
30050	SID 1, AO1	Signed 16	0...100	0,0...10,0 V
30051	SID 1, AO2	Signed 16	0...100	0,0...10,0 V

Register	Parameter description	Data type	Values	Range
30052	SID 2, AO1	Signed 16	0...100	0,0...10,0 V
30053	SID 2, AO2	Signed 16	0...100	0,0...10,0 V
...	...			
30244	SID 98, AO1	Signed 16	0...100	0,0...10,0 V
30245	SID 98, AO2	Signed 16	0...100	0,0...10,0 V
30246	SID 99, AO1	Signed 16	0...100	0,0...10,0 V
30247	SID 99, AO2	Signed 16	0...100	0,0...10,0 V
30248	SID 1, TE	Signed 16		See note 2
30249	SID 1, SP	Signed 16		See note 3
30250	SID 1, RH	Signed 16		See note 4
30251	SID 1, FAN	Signed 16		See note 5
30252	SID 2, TE	Signed 16		See note 2
30253	SID 2, SP	Signed 16		See note 3
30254	SID 2, RH	Signed 16		See note 4
30255	SID 2, FAN	Signed 16		See note 5
...	...			
30636	SID 98, TE	Signed 16		See note 2
30637	SID 98, SP	Signed 16		See note 3
30638	SID 98, RH	Signed 16		See note 4
30639	SID 98, FAN	Signed 16		See note 5
30640	SID 99, TE	Signed 16		See note 2
30641	SID 99, SP	Signed 16		See note 3
30642	SID 99, RH	Signed 16		See note 4
30643	SID 99, FAN	Signed 16		See note 5

Holding registers

Register	Parameter description	Data type	Values	Range
40034	Coils 16 - 01	16 bit		
40035	Coils 32 - 17	16 bit		
...	...			
40045	Coils 192 - 177	16 bit		
40046	Coils 208 - 193	16 bit		
40047	Not in use	16 bit		
40048	Not in use	16 bit		
40049	Not in use	16 bit		
40050	SID 1, AO1	Signed 16	0...100	0,0...10,0 V
40051	SID 1, AO2	Signed 16	0...100	0,0...10,0 V
...	...			
40246	SID 99, AO1	Signed 16	0...100	0,0...10,0 V
40247	SID 99, AO2	Signed 16	0...100	0,0...10,0 V

Notes

Note	Parameter description	Data type	Values	Range
Note 1	When the digital output SID(n) DO(x) is set to On, the analogue output SID(n) AO(x) is not in use			
	When the digital output SID(n) DO(x) is set to Off, the analogue output SID(n) AO(x) is in use			
Note 2	TEFL and LAFL: TE	Signed 16	0...500	0,0...50,0 °C
	HDHFL, TEUFL and KLUFL: TE	Signed 16	-500...1500	-50,0...150,0 °C
	RYFL: AI1	Signed 16	0...100	0,0...10,0 V
	PAFL: single pulse counting	Signed 16	0...999	0...999
Note 3	TEFL: SP	Signed 16	175...245	17,5...24,5 °C
	TEUFL: Uin	Signed 16	0...270	0,0...27,0 V
	HDHFL: CO ₂	Signed 16	0...2000	0...2000 ppm
	KLUFL: LUX	Signed 16	0...1000	0...1000 lx
	LAFL: LUX	Signed 16	0...2000	0...2000 lx
	RYFL: AI2	Signed 16	0...100	0,0...10,0 V
	PAFL: every thousandth pulse counting	Signed 16	0...499	0...499
Note 4	TEFL, HDHFL, KLUFL and LAFL: RH	Signed 16	0...1000	0,0...100,0 %rH
	PAFL, TEUFL ja RYFL: not in use	Signed 16		
Note 5	TEFL-S5: FAN	Signed 16	1 - 2 -3 - 4 - 5	1: A, 2: 0, 3: 1, 4: 2, 5: 3
	TEFL-DI: DI	Signed 16	0 - 1	0: Off, 1: On
	LAFL: PIR	Signed 16	0 - 1	0: Off, 1: On
	HDHFL, PAFL, TEUFL, KLUFL and RYFL: not in use	Signed 16		